

CREATE
your STYLE™
with CRYSTALLIZED™ – Swarovski Elements

DIP INTO PACIFIC EASE

OCEANS OF OPPORTUNITIES AWAIT YOU



THE SUMMER WILL BE
ENDLESS...
Give memories a place for safekeeping



CRYSTALLIZED™ – Swarovski Elements

Article	Product Group	Article No.
	Flat Backs No Hotfix	2028
	Pendants	6790
	Pendants	6791
	Crystal Fabric-it	56000
	Crystal-it	75010
	Crystal-it	75011



CONTRAST PRECIOUSNESS PACIFIC

Whenever you feel the need to slow down, just pause and reflect on the “peaceful sea”. Create a book cover inspired by the motion and reflections of waves rippling out before your eyes towards a new horizon. Your natural inspiration fuses Crystal-its and the

newly launched Crystal Fabric-it by CRYSTALLIZED™ – Swarovski Elements into a precious album perfect for the safekeeping of all your summer memories.

A PERFECT ILLUSION OF A
REFRESHING IMAGE
Simplicity simply couldn't be more irresistible



CRYSTALLIZED™ – Swarovski Elements

Article	Product Group	Article No.
	Flat Backs No Hotfix	2028
	Crystal-it	75010
	Crystal-it	75011



SURFACE DROPS OF WATER ENERGY

Water is one of nature's most precious gifts to us. Capture its spirit on paper in a card. Evoke that special moment in which rolling waves cast shimmering drops of saltwater skyward to hang suspended for an instant before rejoining. All you need are a few

brush strokes and a little colour rubbed through a sieve. Perfection is inevitable with sparkling Crystal-its from CRYSTALLIZED™ – Swarovski Elements.

SPECIAL MOMENTS ARE MADE TO LAST
 How you collect them is an art in its own right



Gluing
 Decorating Paper

CRYSTALLIZED™ – Swarovski Elements

Article	Product Group	Article No.
	Flat Backs No Hotfix	2028
	Flat Backs No Hotfix	2200
	Flat Backs No Hotfix	2300
	Flat Backs No Hotfix	2520
	Beads	5530
	Pendants	6620
	Pendants	6656
	Pendants	6657
	Crystal-it	75010
	Crystal-it	75011



TREASURES MEMORIES DETAILS

You never want to forget your summer holidays at the seaside. This charming little logbook serves as a treasure trove for keeping your fondest memories safe for all time. The sparkling Flat Backs from CRYSTALLIZED™ – Swarovski Elements connote sweet days

spent amidst splashing drops of crystal that symbolize the spray of ocean waves in a photograph. Keep your memories fresh in your mind by hanging it on the wall by one of the strings tied to the binding.

NEW WAVES OF POETIC FANTASY

Send a summer breeze in a greeting card



CRYSTALLIZED™ – Swarovski Elements

Article	Product Group	Article No.
	Flat Backs No Hotfix	2028

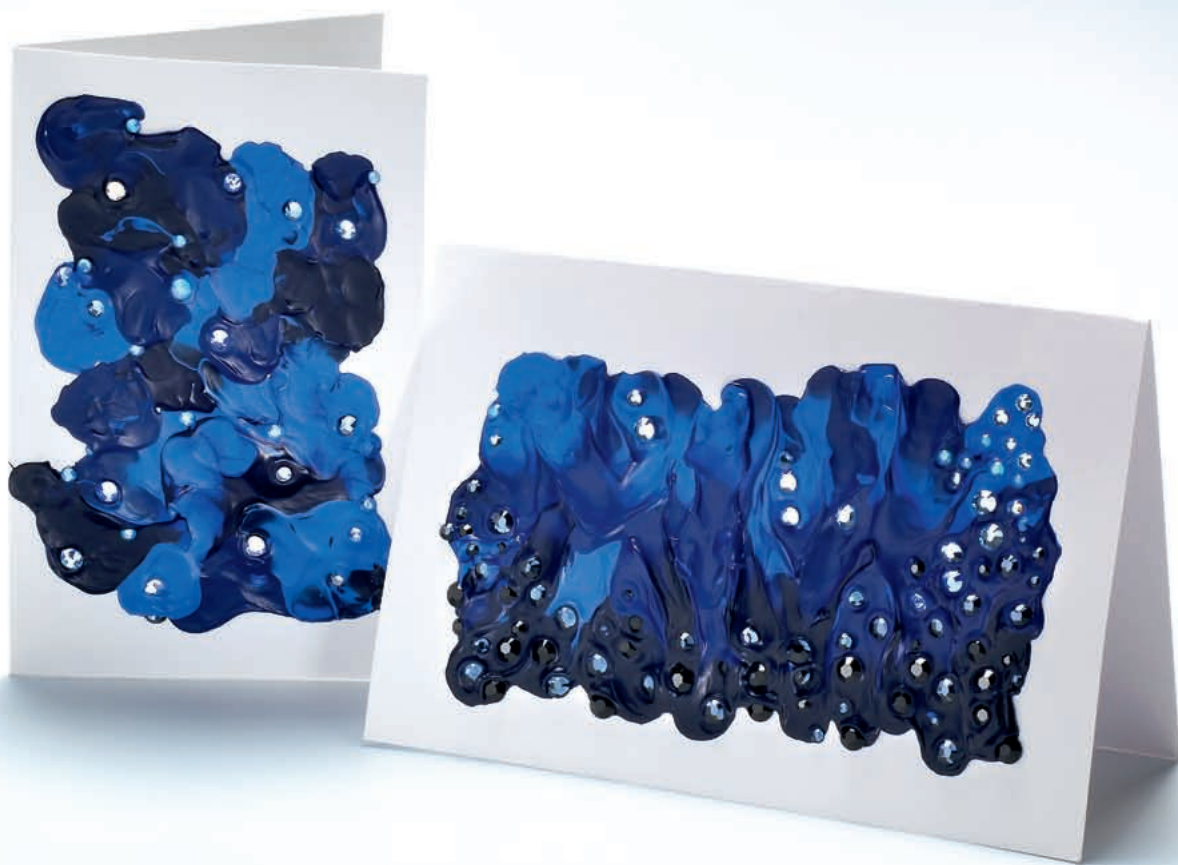

ADVENTURE POETRY FANTASY

By being at once both raw and poetic, deep ocean waves exert a powerful fascination over us. Combine both to create a summer greeting card with the aquatic texture of deep ocean waves. Spread some blots of colour, then weave them together by blowing on the

wet surface through a straw. Now just dip the Flat Backs from CRYSTALLIZED™ – Swarovski Elements in the fresh colour and let it dry. Your gift will evoke daydreams of seaside adventures in the recipient.

EVERY CLICK BRINGS SPARKLING JOY

A gallery of personal masterpieces



CRYSTALLIZED™ – Swarovski Elements

Article	Product Group	Article No.
	Flat Backs No Hotfix	2028
	Flat Backs No Hotfix	2400
	Flat Backs No Hotfix	2483
	Flat Backs No Hotfix	2493
	Flat Backs No Hotfix	2520
	Flat Backs No Hotfix	2555
	Fancy Stones	4756



SUMMER BREEZE FRESHNESS



Your photo of a romantic sunset or any other cherished moment is presented in a lavishly decorated frame clustered with sparkling crystal. Abstract crystal forms look like seashells or parasols and always vividly reflect the light.

Give the smile of those you photograph a sparkle by adorning your camera with a generous layer of CRYSTALLIZED™ – Swarovski Elements.

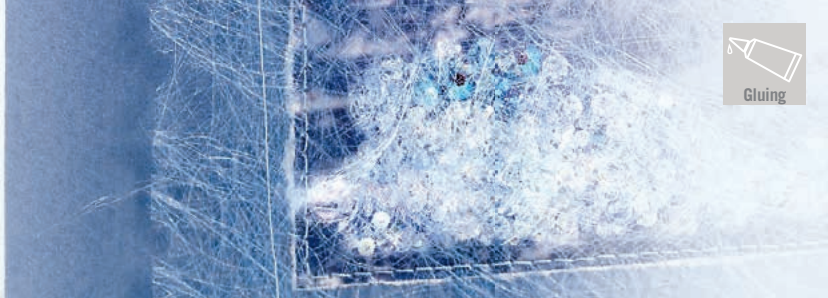
CELEBRATE THE ESSENTIAL
PRECIOUSNESS OF WATER...
Spend a delicious moment of escape



CRYSTALLIZED™ – Swarovski Elements

Article	Product Group	Article No.
	Beads	5000
	Beads	5301

Instruction enclosed

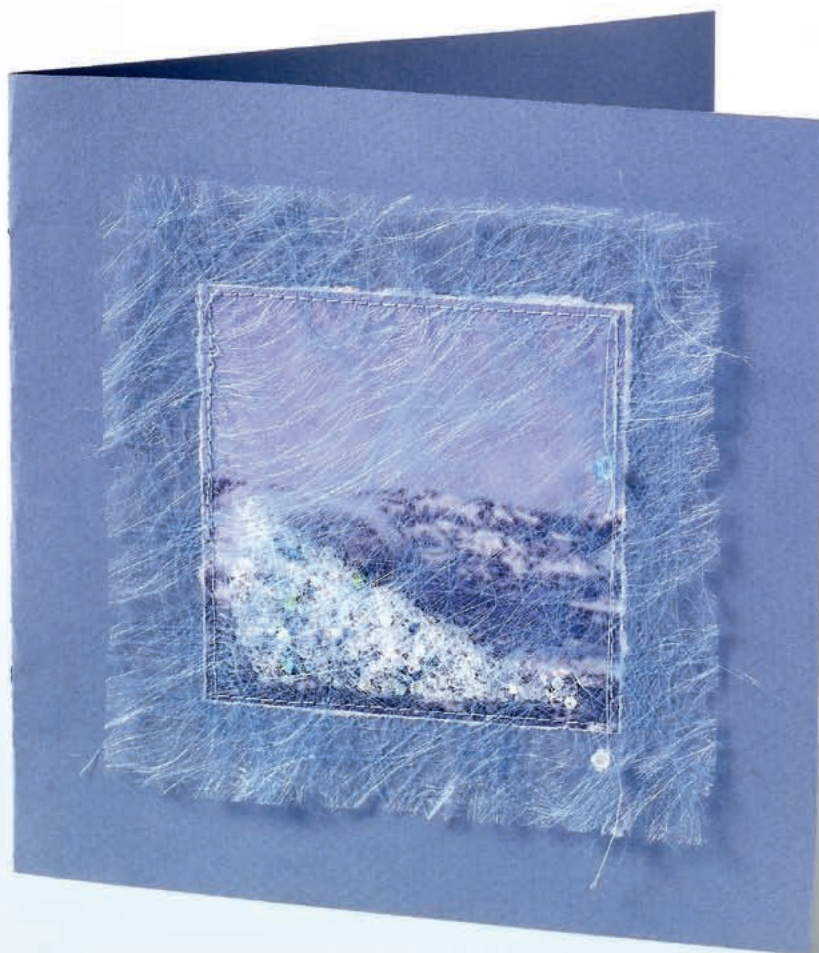

SEA WAVES FASCINATION ESCAPE

What a wonderful gift to those you love most: This card is as brilliant as it is easy to make. Crystal waves from CRYSTALLIZED™ – Swarovski Elements are affixed beneath a semi-transparent cover – in their motions, they resemble bright reflections on water.

The recipient of your gift will want to shake it over and over again to make it ripple like ocean waves – a gift that soothes the spirit like not other.

WAVY GREETING CARD

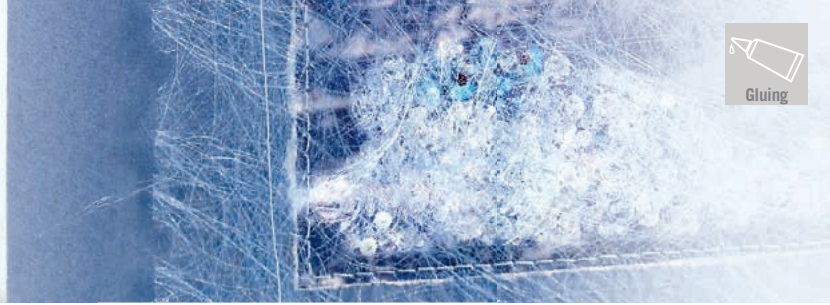

CRYSTALLIZED™ – Swarovski Elements

Supplies & Tools

Article	Product Group	Article No.	Amount	Size	Colour	Colour Code
	Beads	5000	15	2 mm	Capri Blue	243
	Beads	5000	1	2 mm	Crystal AB	001 AB
	Beads	5000	10	4 mm	Aquamarine	202
	Beads	5301	1	4 mm	Aquamarine	202
	Beads	5301	10	3 mm	Crystal AB	001 AB
	Beads	5301	15	3 mm	Crystal	001
	Beads	5301	10	3 mm	Light Sapphire	211
	Beads	5301	10	3 mm	Light Azore	361
	Beads	5301	10	4 mm	Crystal AB	001 AB

- Supplies**
- sewing thread light blue
 - semitransparent fleece paper blue
 - 31 x 15,5 cm card board blue
 - photo printout
- Tools**
- sewing machine
 - scissors
 - sewing needle
 - glue

STEP 1

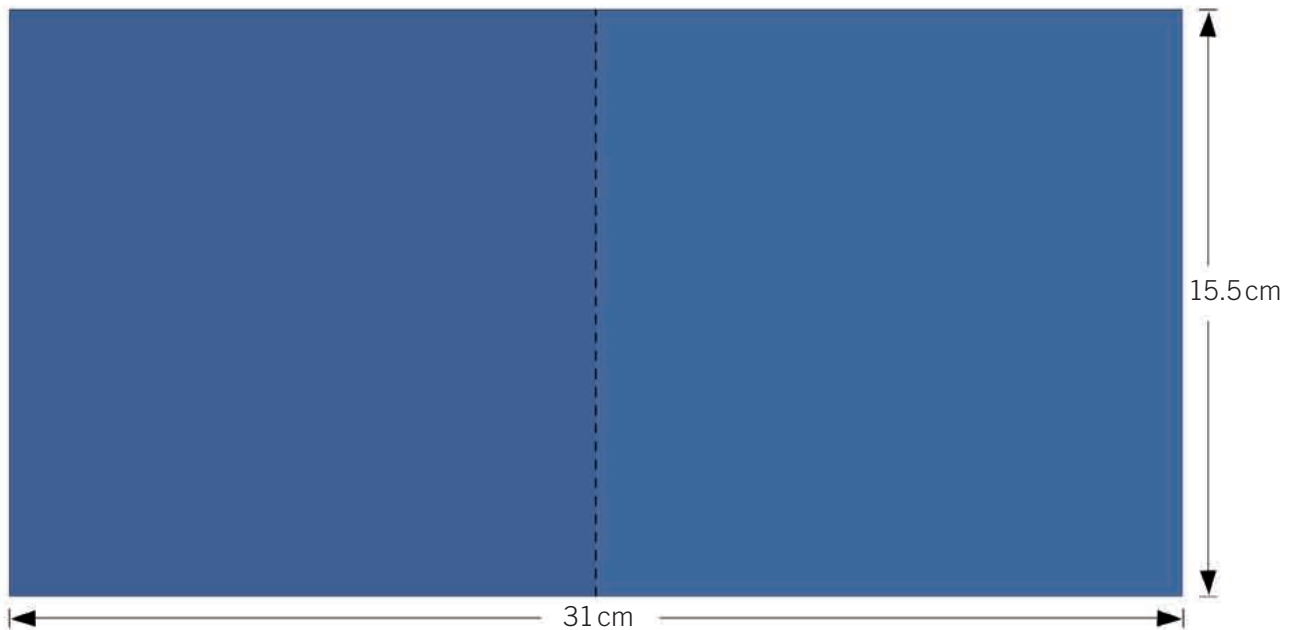

ratio 1 : 2

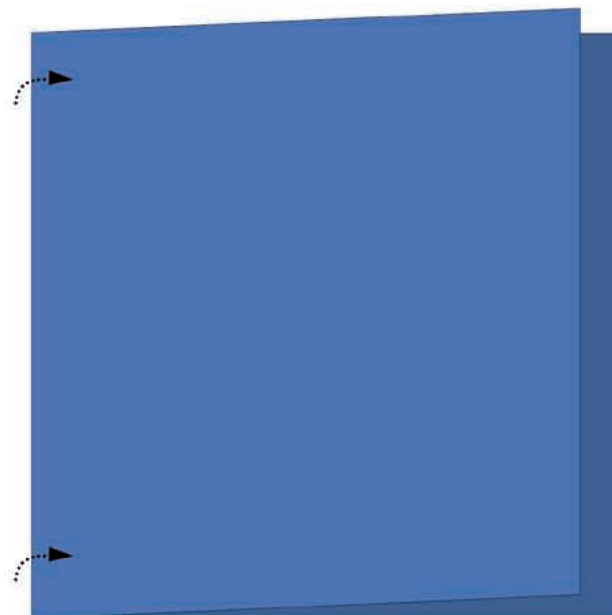

STEP 2

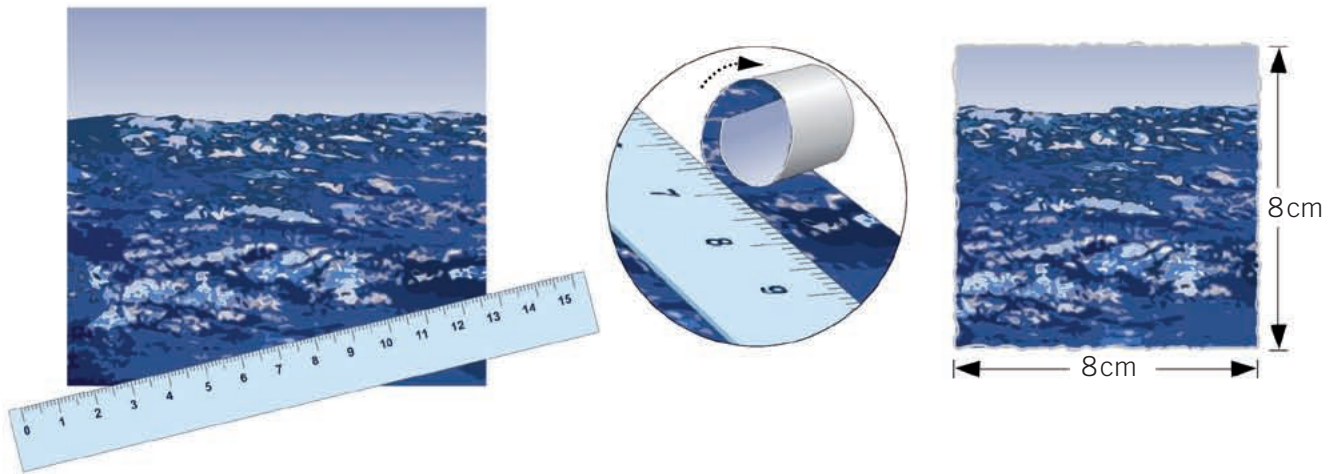

STEP 3



STEP 4

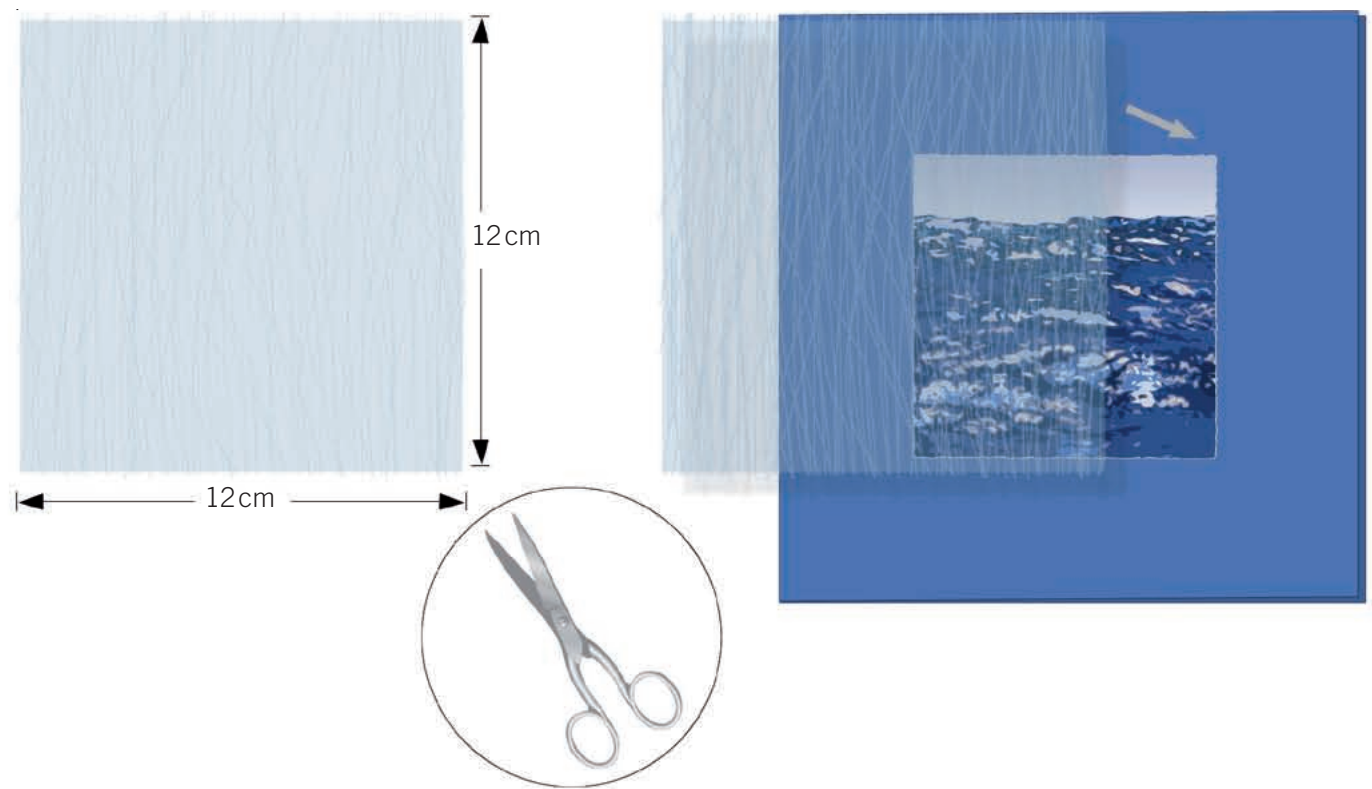

STEP 5

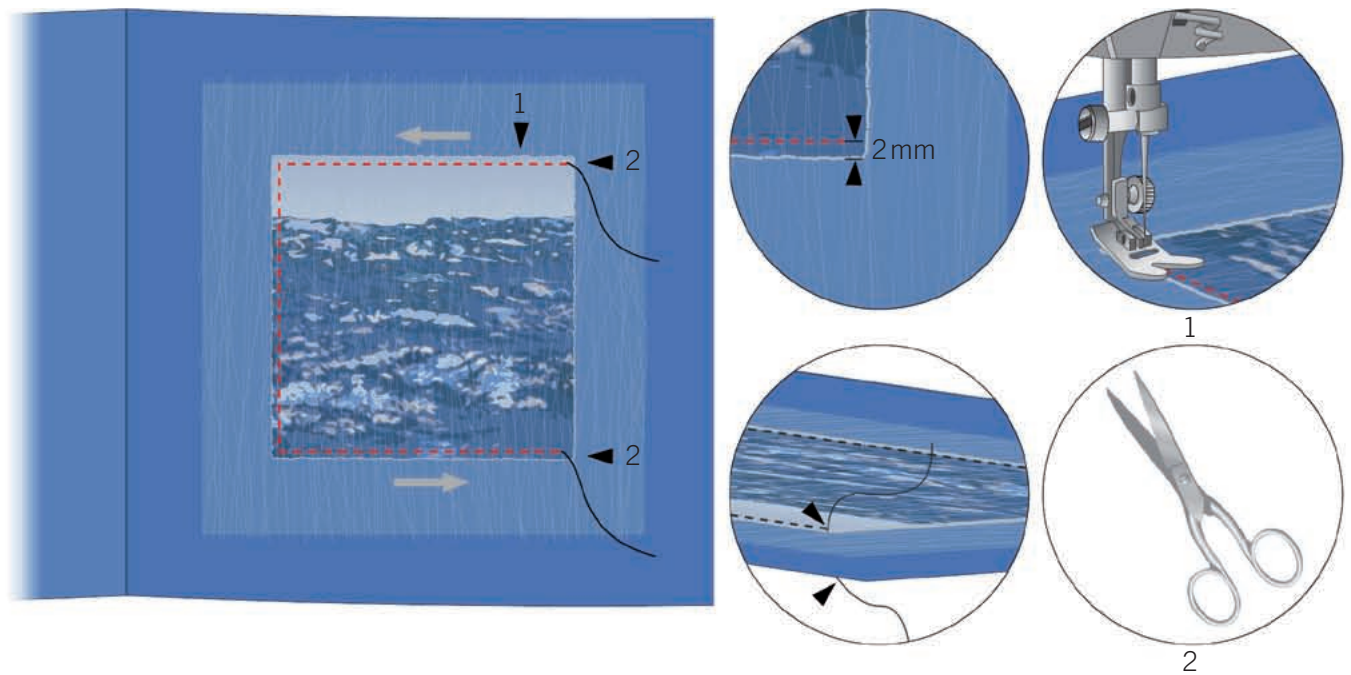

STEP 6

ratio 1 : 1



STEP 7

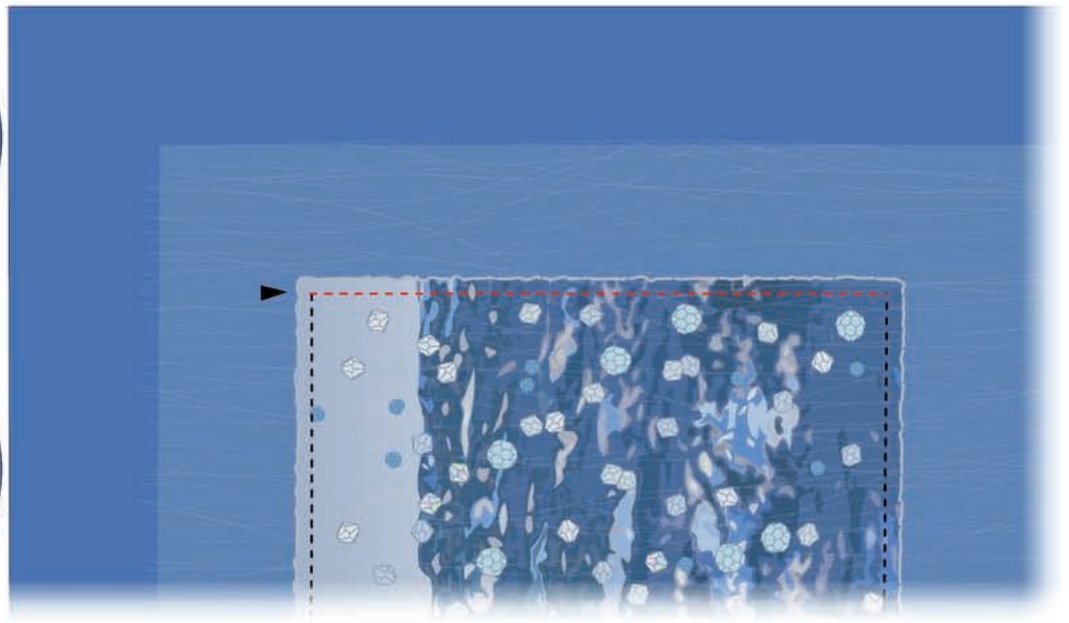
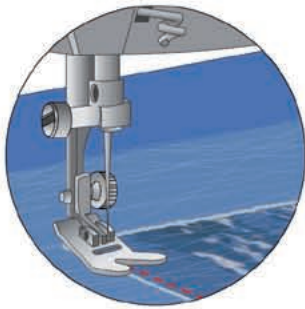
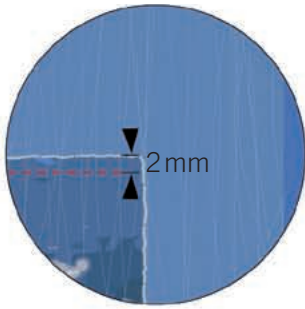

STEP 8

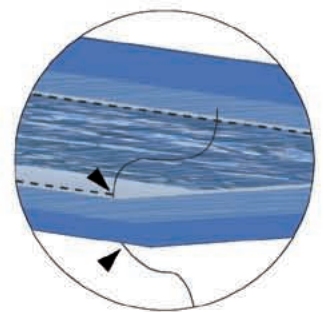
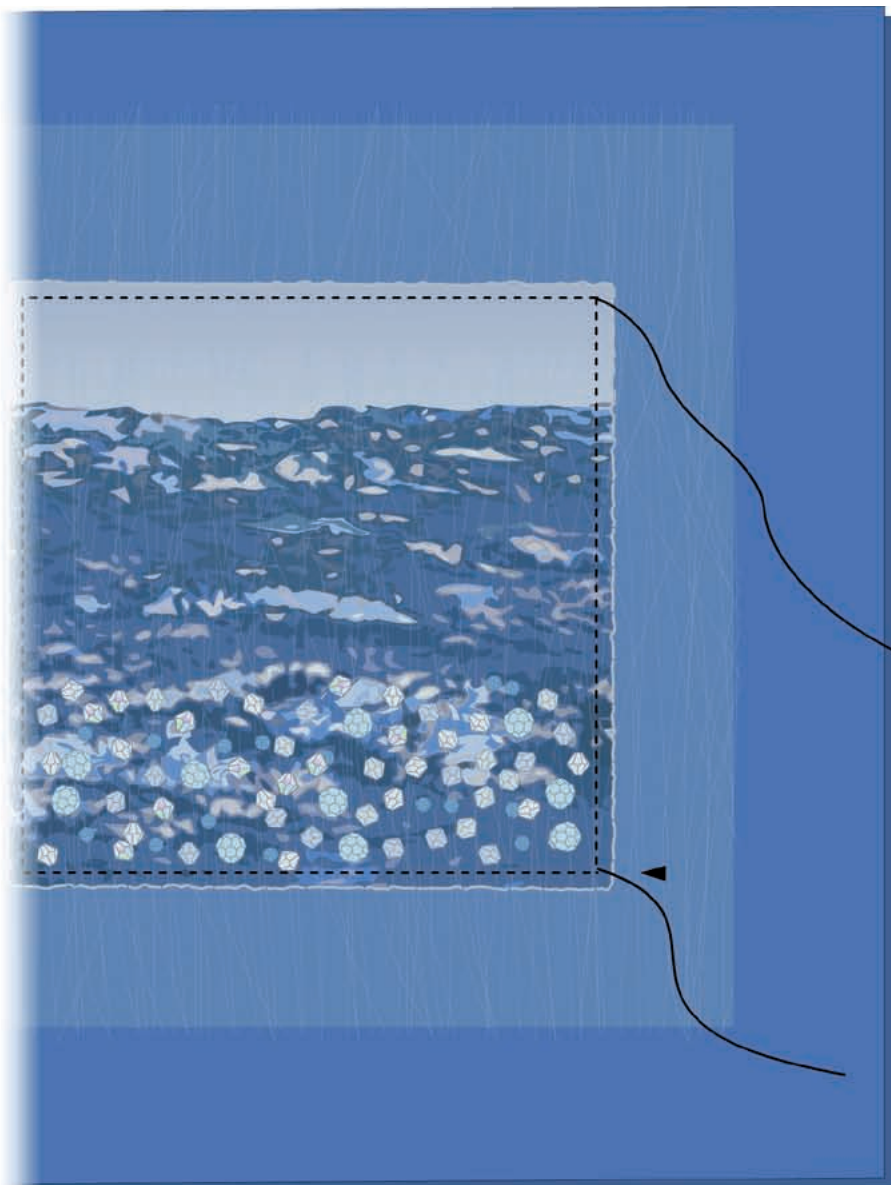

STEP 9

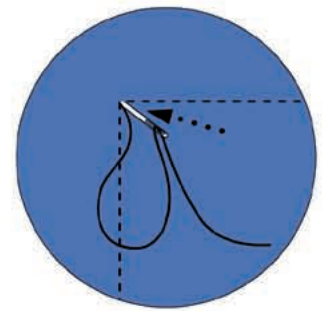
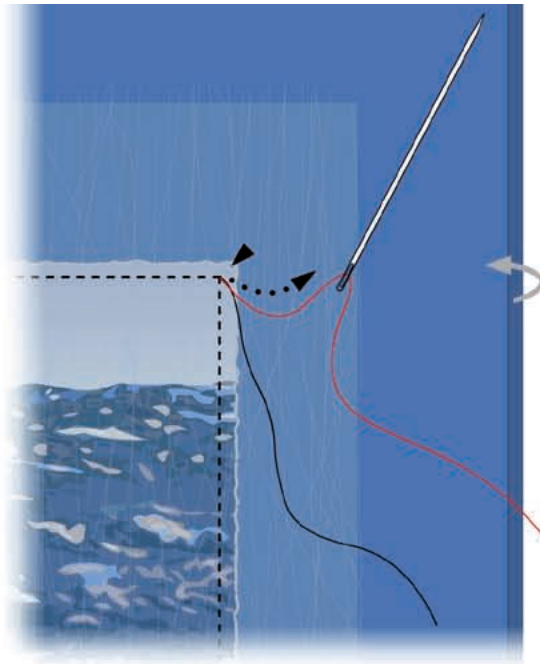

STEP 10

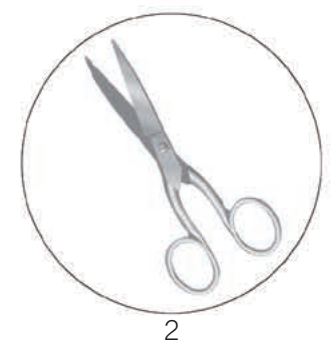
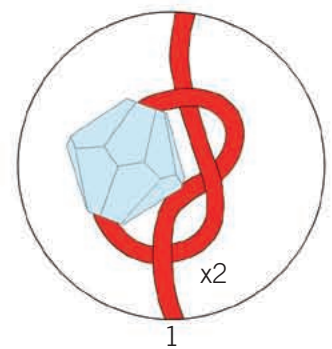
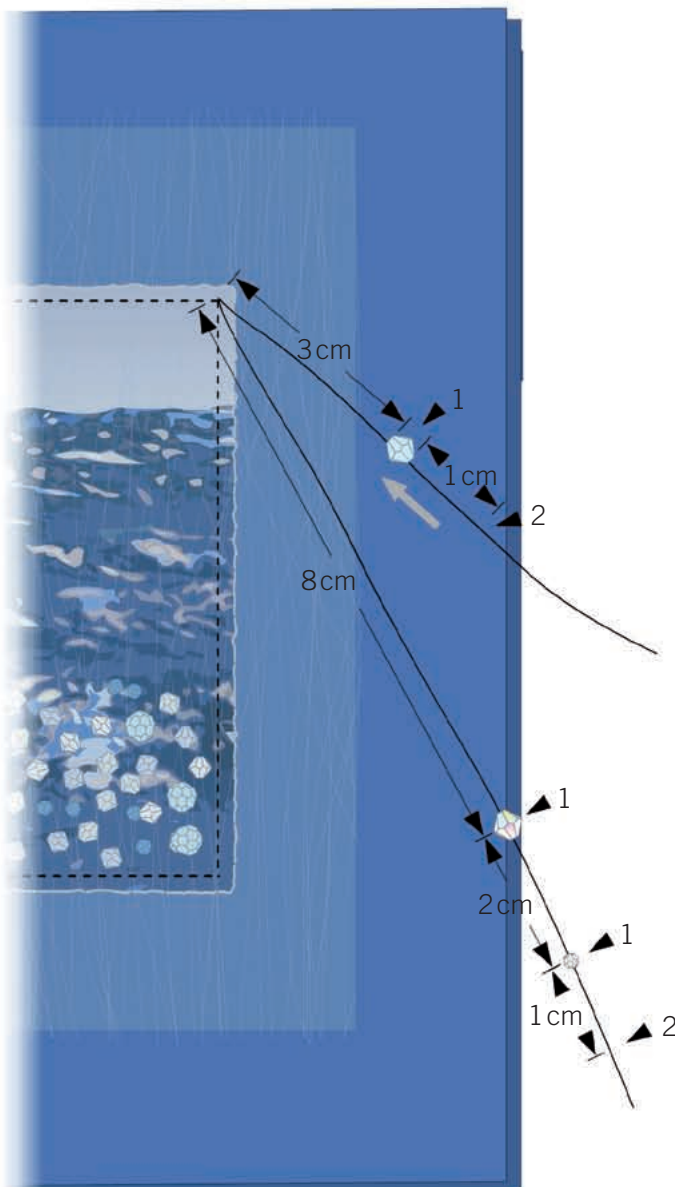

STEP 11

